

D
1

ALUMINUM GREEN POWDER COATED FRAME DOOR COMPLETE WITH ALL ACCESSORIES AND $\frac{3}{8}$ " THK GREEN COLORED GLASS ON COLORED GREEN POWDER COATED FINISH ALUMINUM FRAMING (1.88 M. X 3.00 M)
2 SETS

D
2

ALUMINUM GREEN POWDER COATED FRAME DOOR COMPLETE WITH ALL ACCESSORIES AND $\frac{3}{8}$ " THK GREEN COLORED GLASS ON COLORED GREEN POWDER COATED FINISH ALUMINUM FRAMING (0.95 M. X 2.00 M.)
1 SET

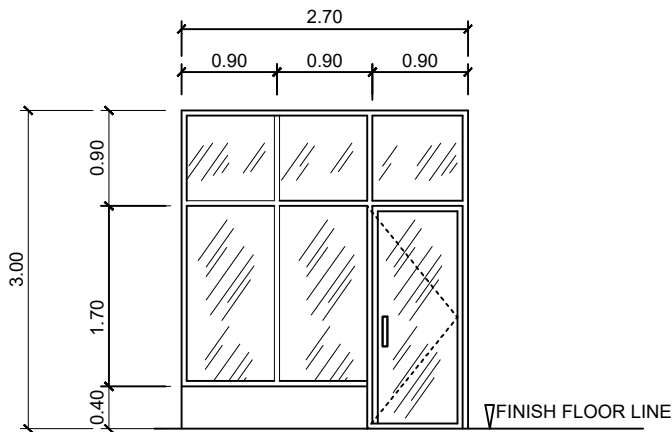

D
3

ALUMINUM GREEN COATED FRAME DOOR COMPLETE WITH ALL ACCESSORIES AND $\frac{3}{8}$ " THK GREEN COLORED GLASS ON COLORED GREEN POWDER COATED FINISH ALUMINUM FRAMING (2.70 M. X 3.00 M.)
2 SETS

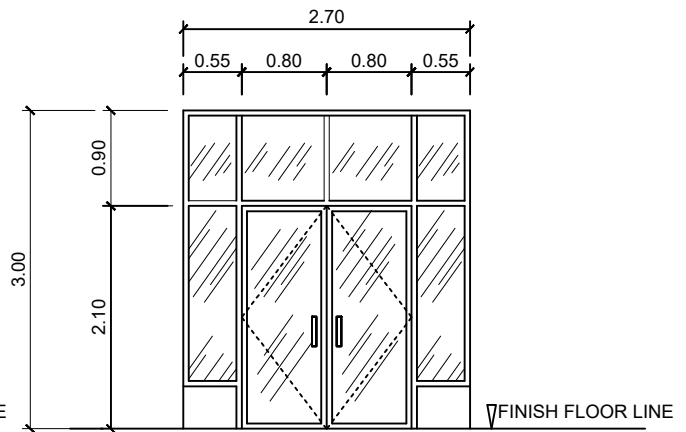

D
4

ALUMINUM GREEN COATED FRAME DOOR COMPLETE WITH ALL ACCESSORIES AND $\frac{3}{8}$ " THK GREEN COLORED GLASS ON COLORED GREEN POWDER COATED FINISH ALUMINUM FRAMING (2.70 M. X 3.00 M.)
1 SETS

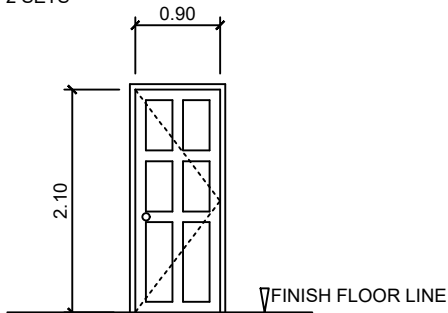

D
5

STEEL WHITE COATED PANEL DOOR WITH COMPLETE ACCESSORIES (0.90 M. X 2.10 M.)
10 SETS

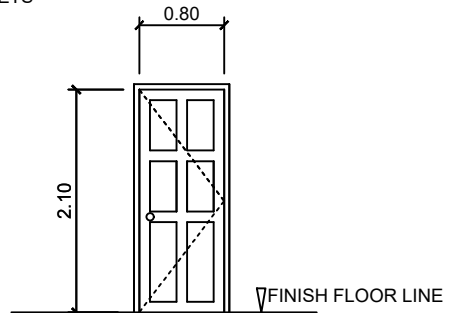

D
6

STEEL WHITE COATED PANEL DOOR WITH COMPLETE ACCESSORIES (0.80 M. X 2.10 M.)
3 SETS



SCHEDULE OF DOORS

SCALE

1: 50 M.

BID BULLETIN

BAHAY NG ALUMNI

CAVITE STATE UNIVERSITY , MAIN CAMPUS

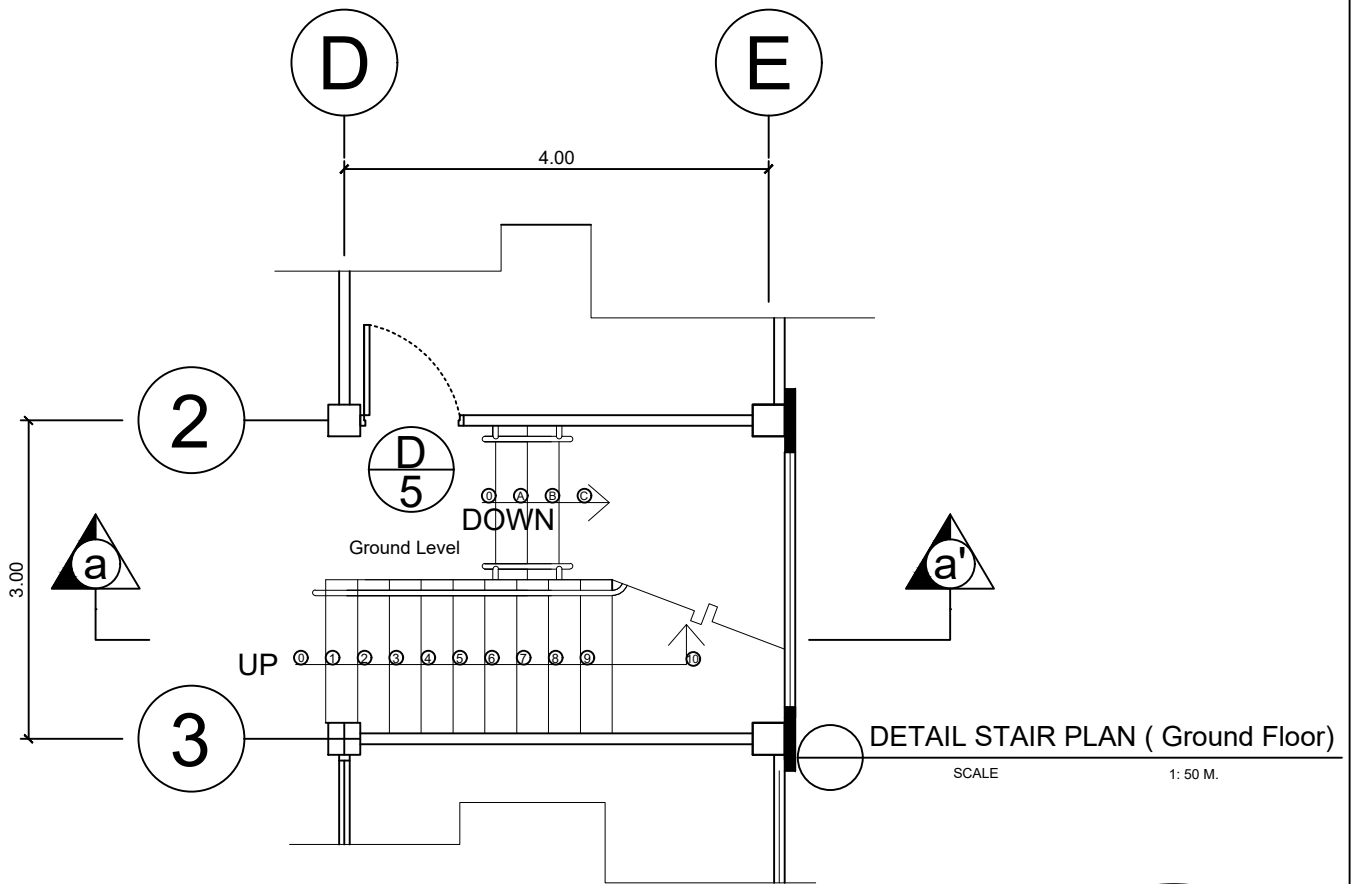

Note: Adopt the design of Stair Railing at the Administrative Building

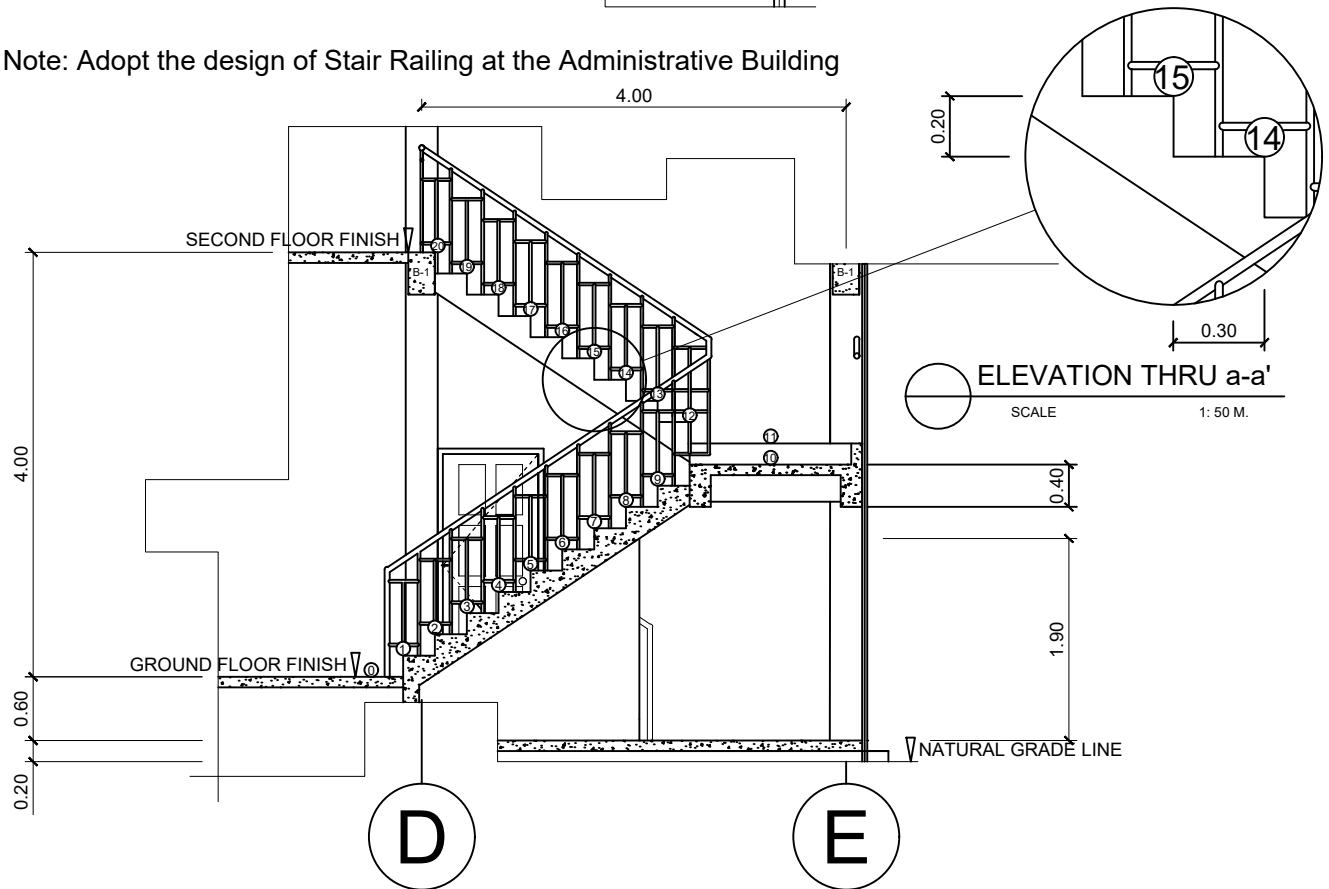

BID BULLETIN
BAHAY NG ALUMNI
 CAVITE STATE UNIVERSITY , MAIN CAMPUS

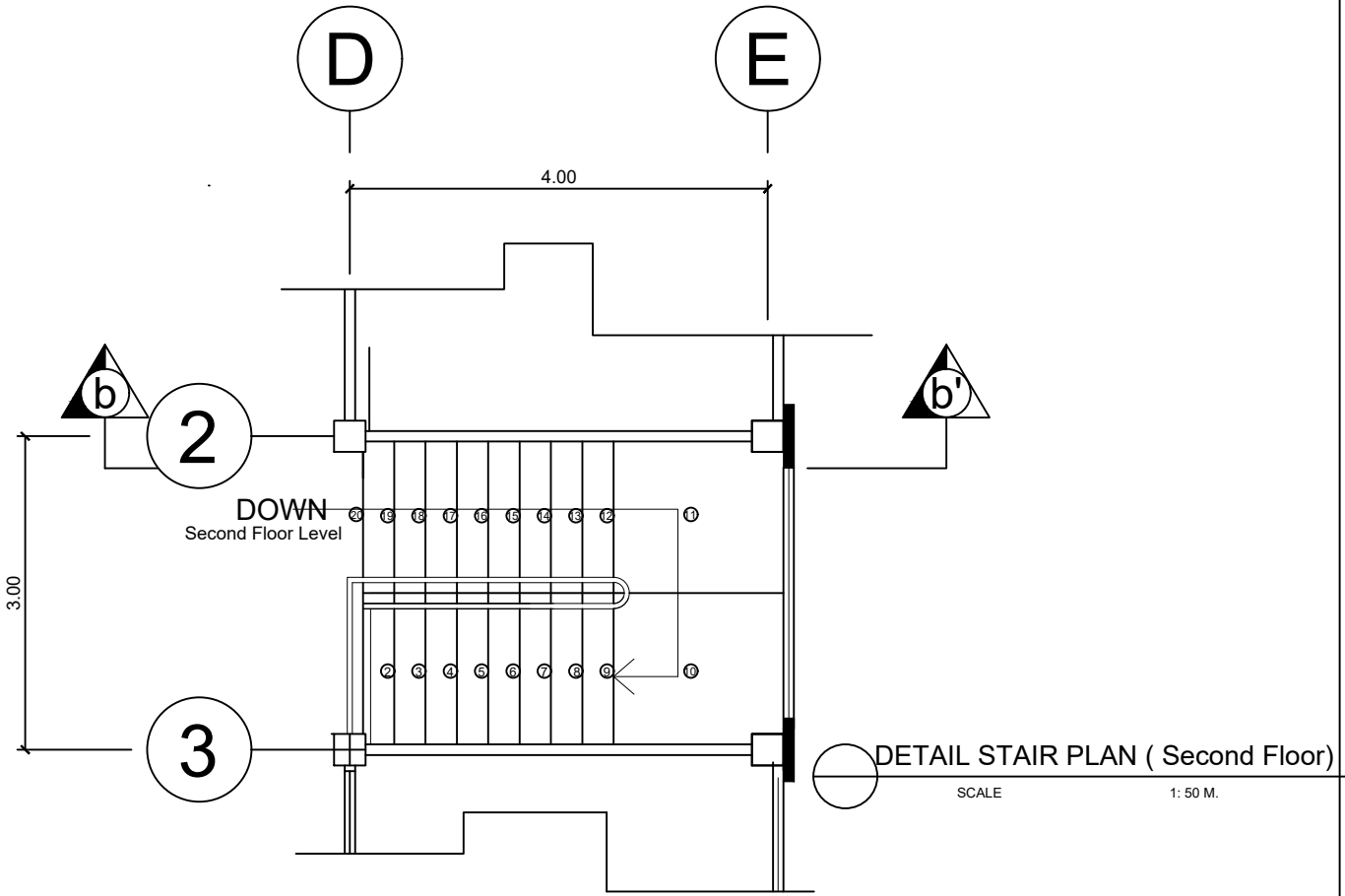

Note: Adopt the design of Stair Railing at the Administrative Building

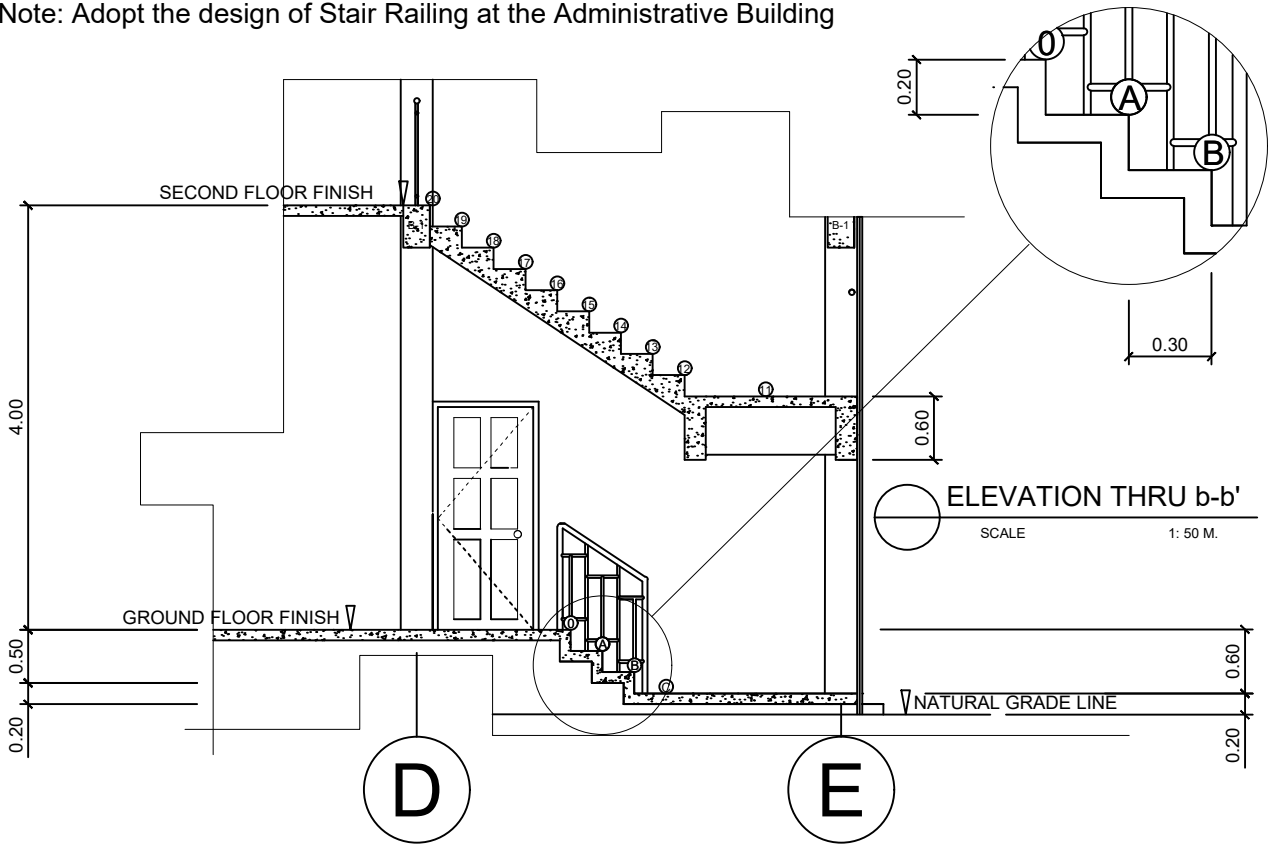

BID BULLETIN
BAHAY NG ALUMNI
CAVITE STATE UNIVERSITY , MAIN CAMPUS

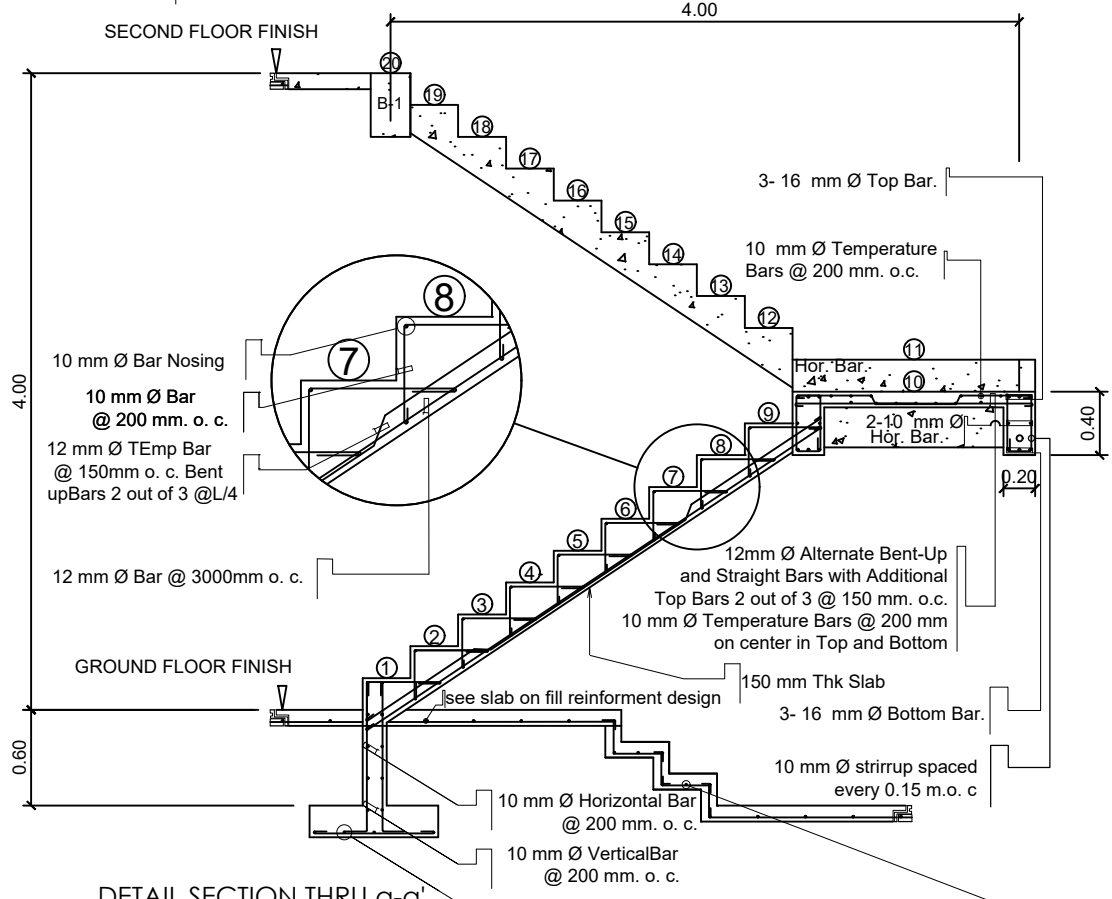
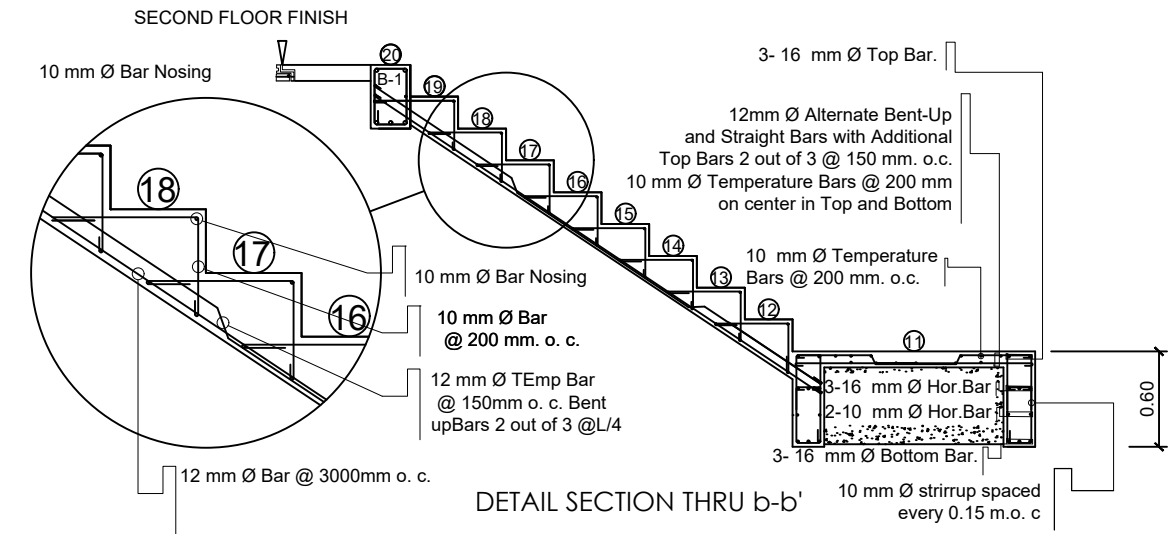

DETAILS OF R.C. STAIR SECTION
 SCALE NTC
 10 mm Ø Traverse Bar @ 0.20 m. o. c. and 3- 10 Ø Longitudinal Bar

BID BULLETIN
BAHAY NG ALUMNI
 CAVITE STATE UNIVERSITY , MAIN CAMPUS