



**FOURTH FLOOR PLAN**  
 SCALE: 1:200 MTS.

**LEGEND:**

 NON-EXISTENT  
 EXISTING

PREPARED BY: <i>J. D. Escano</i> J. D. ESCANO PPU OVPPD		ENDORSED BY: <i>O. B. Luis Reyes</i> O. B. LUIS REYES DIRECTOR PLANNING OFFICE		REC. APPROVAL: <i>M. M. Escobar</i> M. M. ESCOBAR VPPD CVSU		APPROVED BY: <i>H. D. Nobles</i> H. D. NOBLES PRES CVSU		PROJECT TITLE/ LOCATION: PROPOSED PARTITION WALL ON FOURTH FLOOR OF CVSU BACCOOR CAMPUS ACADEMIC BLDG. CAVITE STATE UNIVERSITY BACCOOR CAMPUS		IMPLEMENTING AGENCY CAVITE STATE UNIVERSITY		SHT NO: A - 1	
END USER: <i>M. Macalalad</i> M. MACALALAD DEAN BACCOOR CAMPUS													

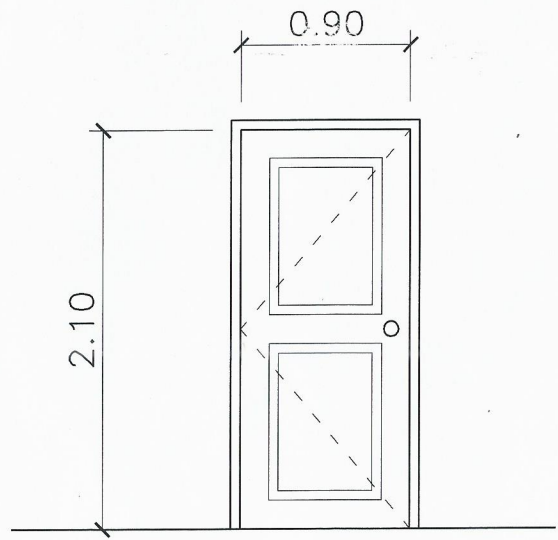

**D**  
**1** 0.90 X 2.10 STEEL DOOR  
W/ COMPLETE ACCESSORIES  
36 SETS

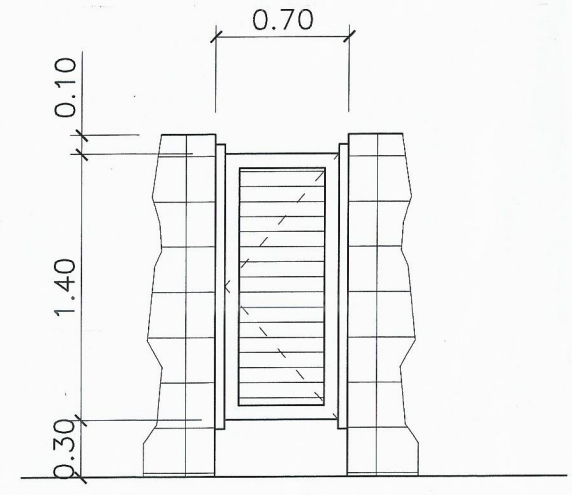

**D**  
**2** 0.70 X 1.40 PVC DOOR W/ COMPLETE  
ACCESSORIES AND PARTITION  
10 SETS

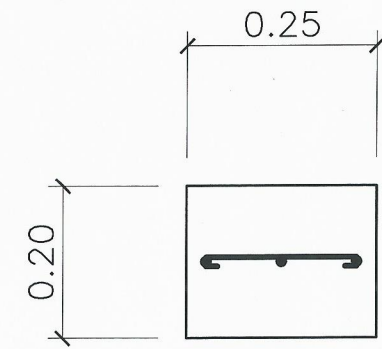

**STIFFENER COLUMN**

0.20m x 0.25m W/ 3-12mm  $\phi$   
VERTICAL BARS W/ 10mm  $\phi$  TIES @  
2-50mm, 4-75mm, 6-100mm, REST @  
200mm O.C.

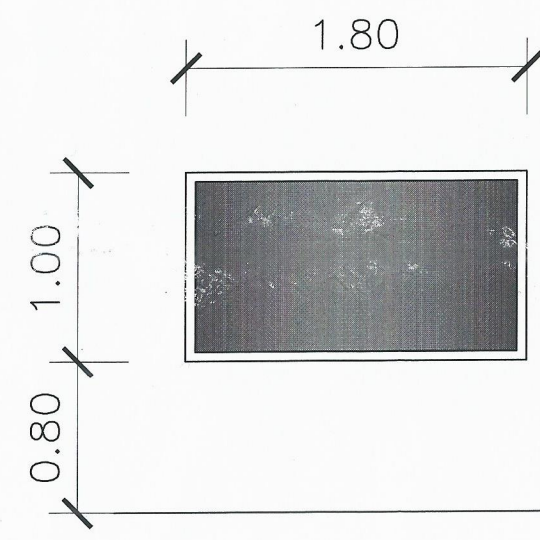
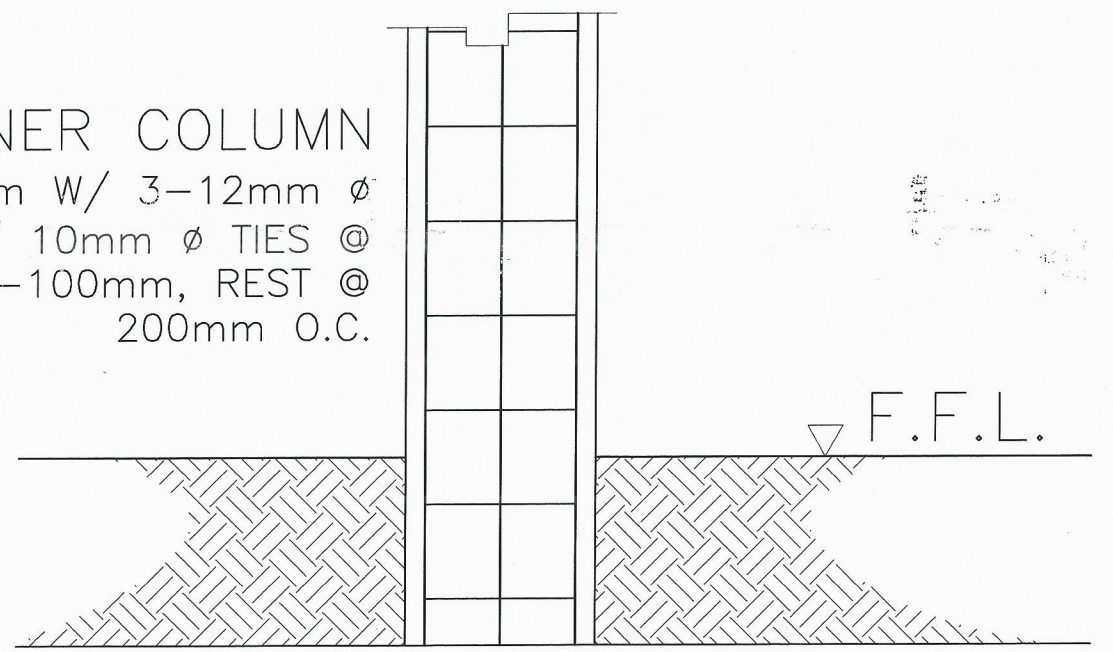

**W**  
**1** ALUMINUM FIXED WINDOW COMPLETE W /  
ALL ACCESSORIES W /  $\frac{1}{4}$ " THK CLEAR GLASS  
32 SETS

**SCHEDULE OF DOORS AND WINDOWS**  
SCALE: 1:40 MTS.

**DETAILS OF STIFFENER COLUMN**  
SCALE: 1:10 MTS.

PREPARED BY: J. D. ESCANO PPU		ENDORSED BY: O. B. DELOS REYES DIRECTOR PLANNING OFFICE		REC. APPROVAL: M. M. ESCOBAR VPPD CVSU	APPROVED BY: C. A. POLINGA VPASS CVSU	APPROVED BY: H. D. ROBLES PRES CVSU	PROJECT TITLE/ LOCATION: PROPOSED PARTITION WALL @ 4TH FLOOR OF CVSU BACOR CAMPUS ACADEMIC BLDG. CAVITE STATE UNIVERSITY BACOR CAMPUS	IMPLEMENTING AGENCY: CAVITE STATE UNIVERSITY	SHT NO: A - 2
END USER: M. MACALALAD DEAN BACOR CAMPUS									